

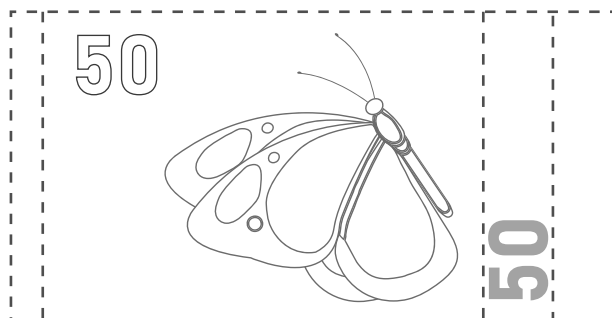

小活動

1. 請為以下紙幣塗上正確的顏色

沿虛線剪下錢幣，
並掃描QR Code 學製環保收銀機，
展開模擬購物之旅！

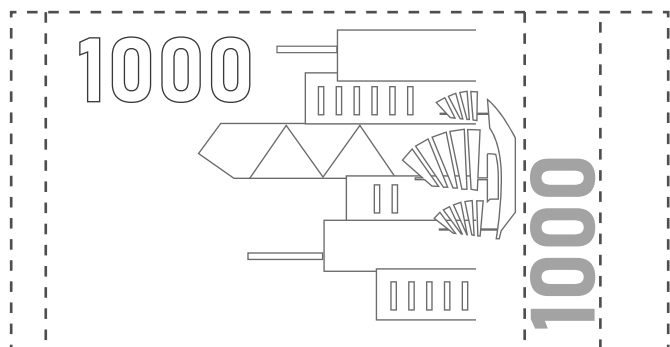
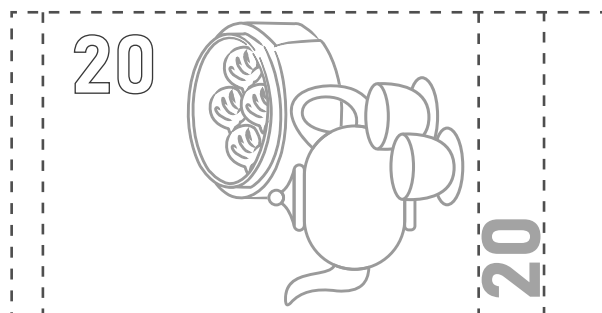
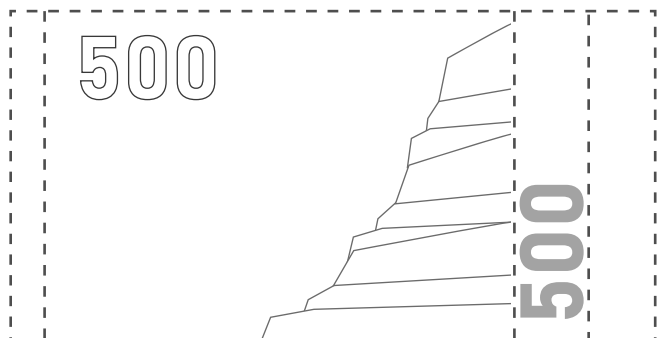
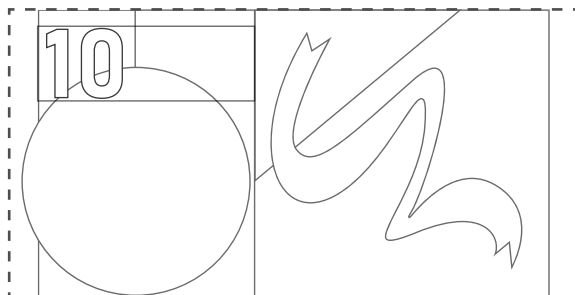
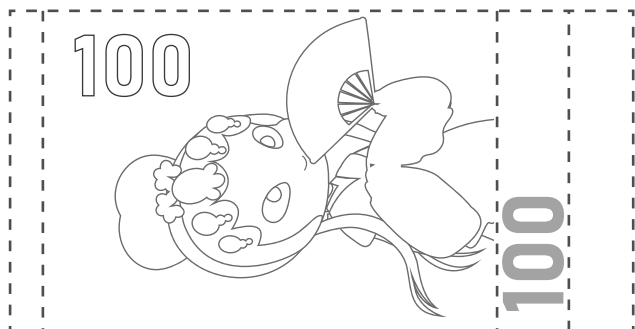

2. 找出相應硬幣，把硬幣放在紙後，用鉛筆掃描出來



\$1	\$2	\$5	
\$10	\$0.5	\$0.2	\$0.1



學習小貼士

分辨硬幣與紙幣時要留意顏色和形狀。





小活動

1. 請為以下紙幣塗上正確的顏色



沿虛線剪下錢幣，
並掃描QR Code 學製環保收銀機，
展開模擬購物之旅！

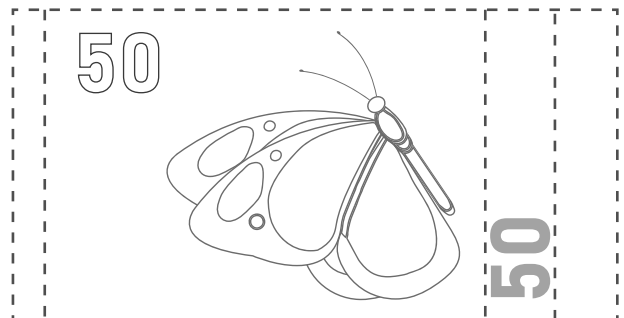
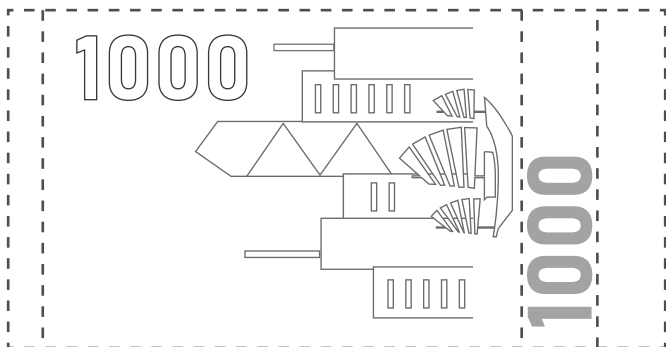
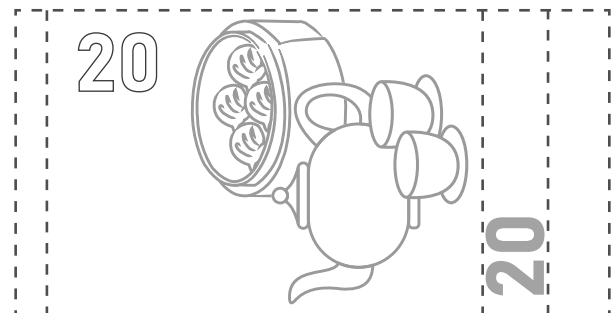
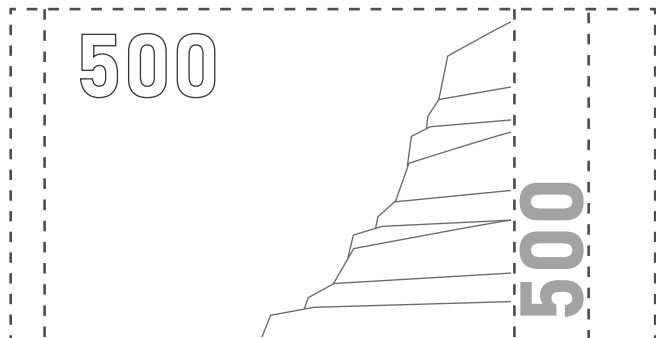
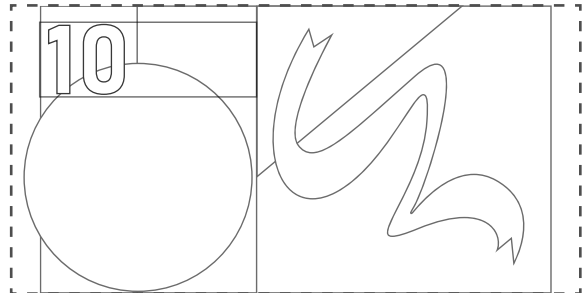
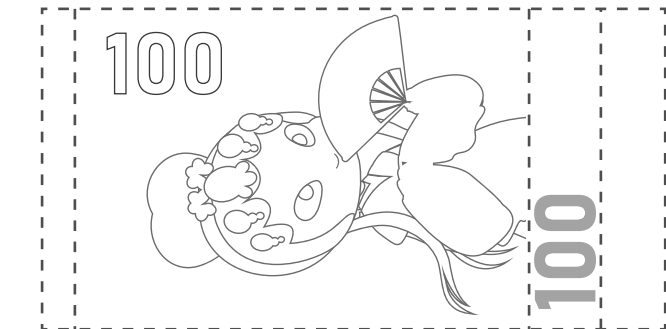

2. 找出相應硬幣，把硬幣放在紙後，用鉛筆掃描出來

給父母的建議：小朋友可參考動畫 2 (硬幣與紙幣) 的銀紙樣本，替紙幣填上適當的顏色。

\$1 	\$2 	\$5 	
\$10 	\$0.5 	\$0.2 	\$0.1



學習小貼士

分辨硬幣與紙幣時要留意顏色和形狀。



你知道以下銀紙包含了哪些防偽特徵嗎?填寫對應的數字吧!



- 1 動感光亮圖案
- 2 熒光透視銀碼
- 3 凹凸手感
- 4 高透光水印
- 5 隱藏銀碼
- 6 開窗金屬線



小實驗

試拿出一張新版銀紙，
把它輕微傾斜時，你見
到哪些防偽特徵呢？

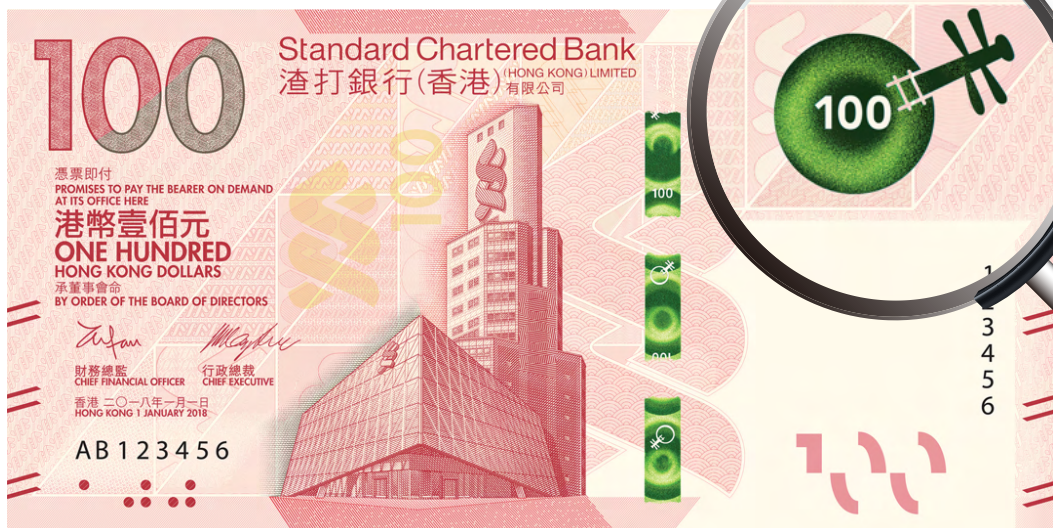

學習小貼士

金管局透過兩部收銀車於全港遊走，替市民免費收集硬幣，並將收集的硬幣再回流市面使用，提高硬幣流通，減少鑄造新幣需要。市民可將硬幣轉換成銀紙或增值至儲值支付工具，或將款項存入車內的捐款箱。





你知道以下銀紙包含了哪些防偽特徵嗎?填寫對應的數字吧!

- 1 動感光亮圖案
- 2 熒光透視銀碼
- 3 凹凸手感
- 4 高透光水印
- 5 隱藏銀碼
- 6 開窗金屬線



小實驗
試拿出一張新版銀紙，
把它輕微傾斜時，你見
到哪些防偽特徵呢？

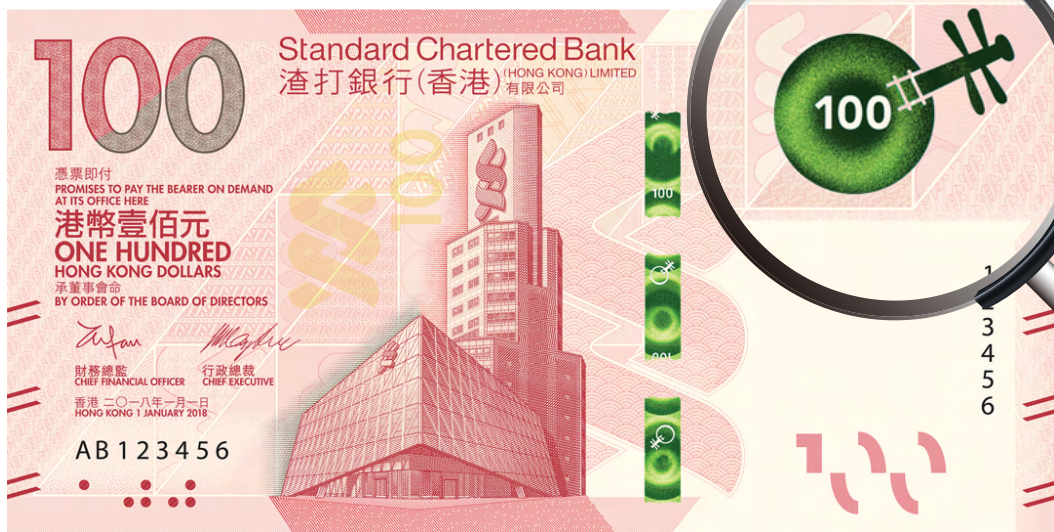

學習小貼士

金管局透過兩部收銀車於全港遊走，替市民免費收集硬幣，並將收集的硬幣再回流市面使用，提高硬幣流通，減少鑄造新幣需要。市民可將硬幣轉換成銀紙或增值至儲值支付工具，或將款項存入車內的捐款箱。

